

## interior industrial door

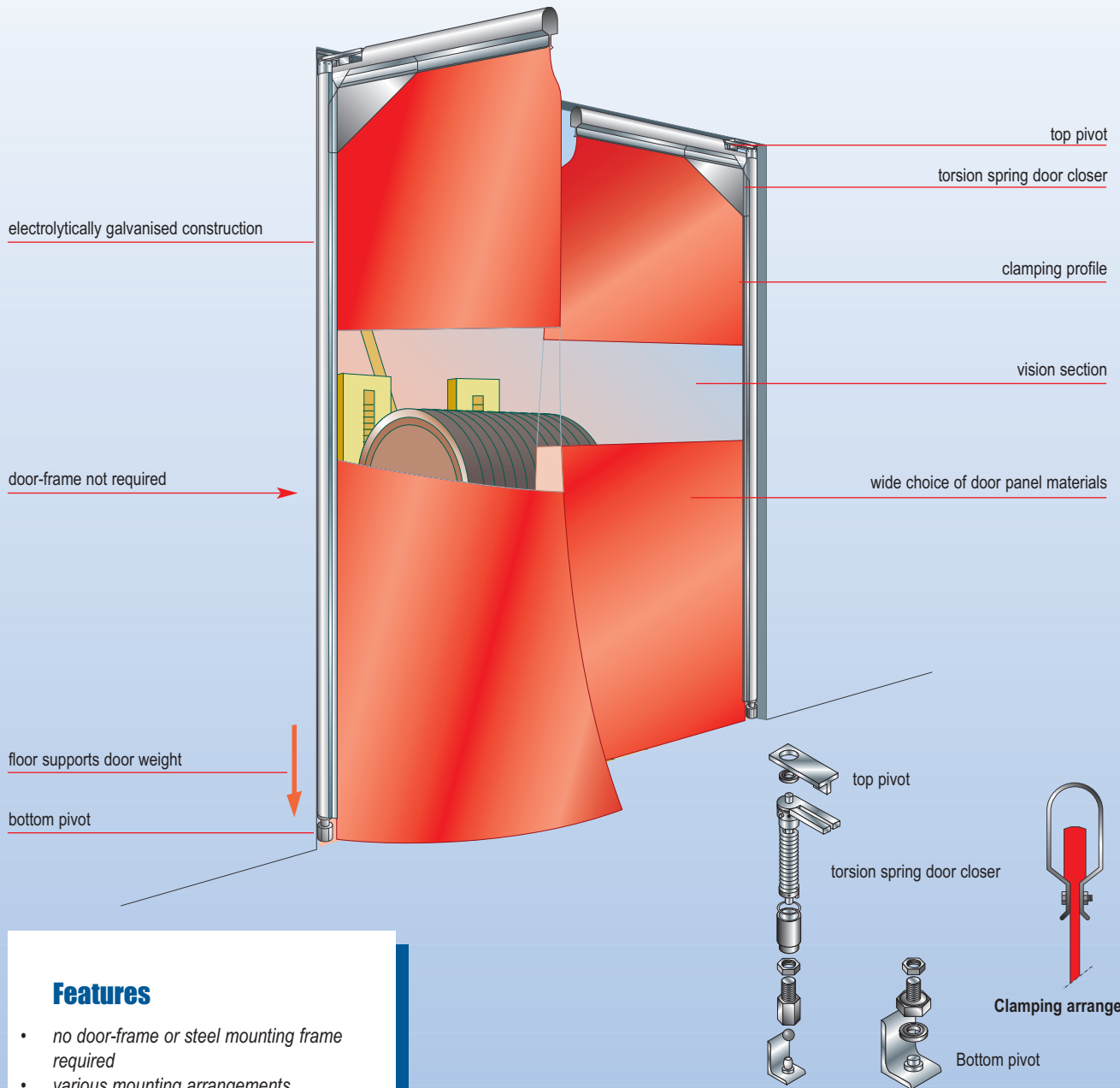

### Features

- no door-frame or steel mounting frame required
- various mounting arrangements
- wide choice of door panel materials
- electrolytically galvanised as standard
- choice of colours (RAL)
- also available in stainless steel (304).

#### Many extras, such as:

- raised bottom pivot
- vision panel, windows or portholes

*Novoferm's PTL climate control doors create a functional separation between two areas without impeding the passage of personnel and materials handling equipment, as the door can simply be pushed open. These doors are used in industrial buildings and public utilities.*

## Components and construction

Novoferm PTL climate control doors are available as single or double leaf designs. The doors consist of a frame made of steel clamping profiles (gallows construction). There is a choice of rubber or flexible plastic door leaf materials, in a variety of thicknesses, grades and colours and with various vision options. The top pivots are fitted with ball bearings, the bottom pivots use a ball collar thrust bearing. The doors close automatically under the influence of a torsion spring door closer, which can be adjusted from the outside and is mounted in the top part of the vertical tube where it is protected against dust and from the effects of collisions.

## Mounting arrangements

- 1) 2 x 90° (standard)
- 2) 1 x 90° and 1 x 180°

## Materials

### construction

- pressed steel plate, electrolytically galvanised (or stainless steel 304).

### door leaf

- transparent plastic sheet (5 and 7 mm) (1)
- reinforced transparent plastic sheet (7 mm thick) (1)
- wear-resistant black rubber, 6 and 8 mm thick, with inlays
- ivory, black, grey, red or brown plastic sheet, 7 mm thick.

### windows

- vision panel at a height between 1250 and 1750 mm from the floor
- high-frequency welded windows
- portholes fitted with safety glass.

## Finish

The steel parts of the door are electrolytically galvanised.

## Afmetingen

- max. width.....3000 mm
- max. height.....3000 mm
- max. surface area.....8 m<sup>2</sup>

## Operators

The forklift truck pushes the door open, following which the door automatically closes under the influence of the integral door closer.

## Structural requirements

Installation of Novoferm's PTL climate control door does not require the presence of a door-frame around the periphery of the opening. The entire weight of the door bears on the floor. A steel or concrete lintel is sufficient.

## Auxiliary components/ options/ accessories

- door stop
- mounting plate with welded pivots
- three-sided door-frame fitted with pivots

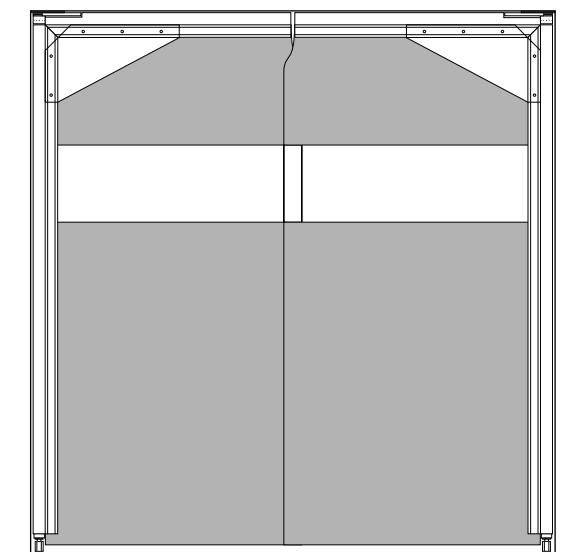

aanzicht

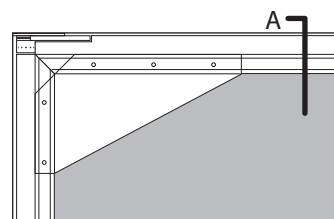

detail



Section A

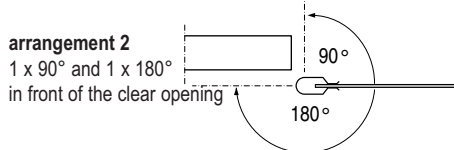
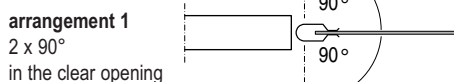

## interior industrial door

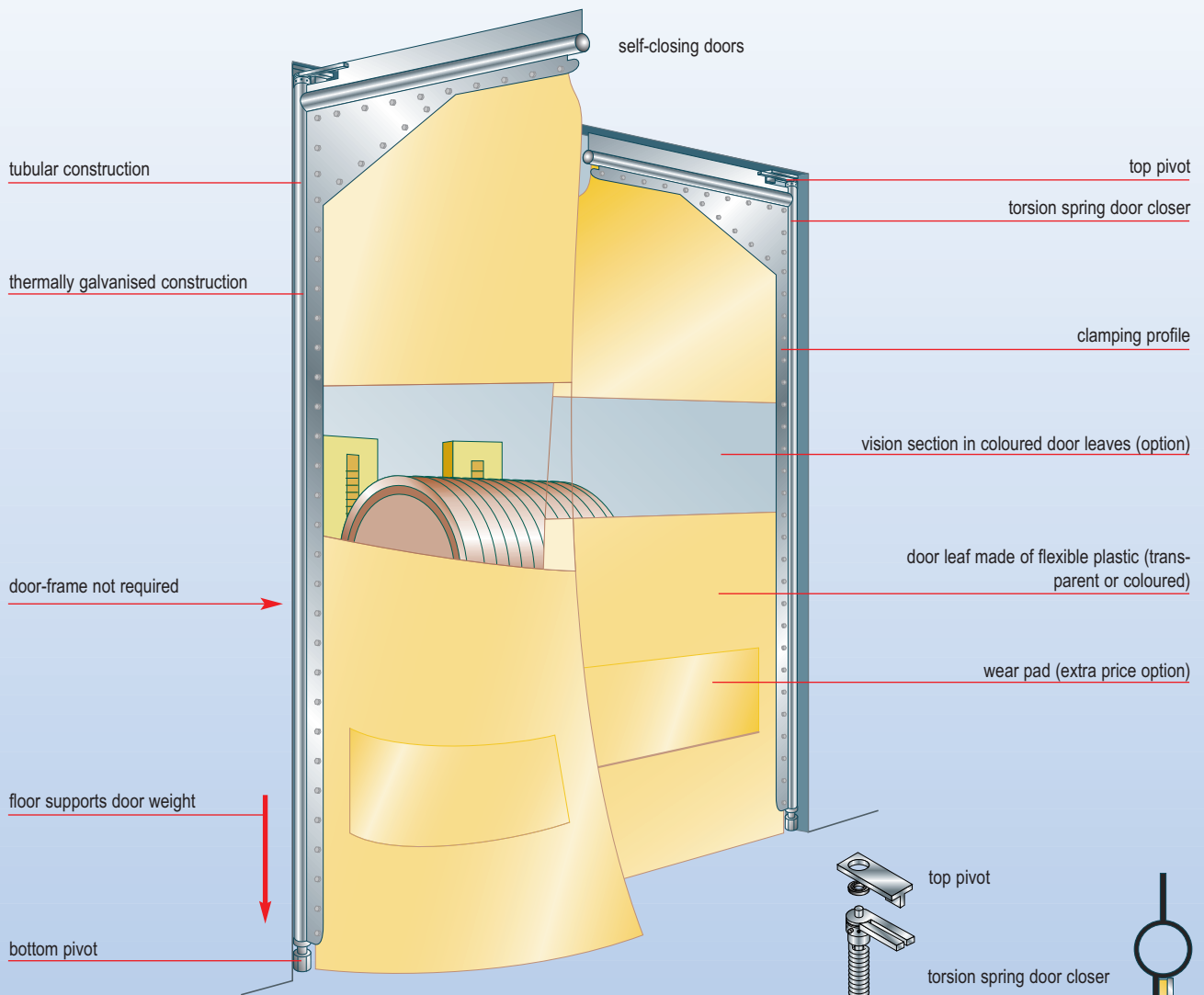

### Features

- no steel mounting frame required
- various mounting arrangements
- wide choice of door panel materials
- thermally galvanized as standard
- choice of colours (RAL)
- also available in stainless steel (304).

### Many extras, such as:

- wear pads
- raised bottom pivot
- reinforced cut-outs
- vision panel, windows or portholes
- pneumatic door openers
- electric door openers.

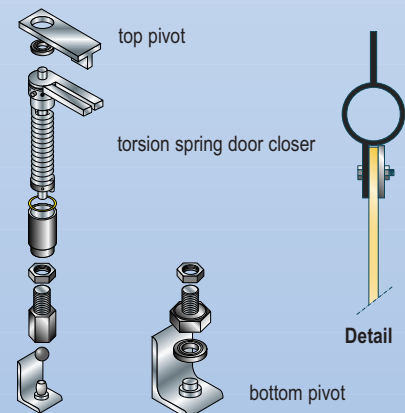

*Novoferm swing doors create a functional separation between two areas without impeding the passage of personnel and materials handling equipment, as the door can simply be pushed open. These doors are used in industrial buildings and public utilities.*

## Components and construction

Novoferm's PTS swing doors are available as single or double leaf designs; in a variety of construction types and suitable for several different mounting arrangements. The doors consist of a steel frame fabricated from tube and strip (gallows construction), dimensioned to suit the size of the door. There is a choice of rubber or flexible plastic door leaf materials, in a variety of thicknesses, grades and colours and with various vision options. The top pivots are fitted with ball bearings, the bottom pivots use a ball collar thrust bearing (or a swivel bearing). The doors close automatically under the influence of a torsion spring door closer, which can be adjusted from the outside and is mounted in the top part of the vertical tube where it is protected against dust and from the effects of collisions.

## Mounting arrangements

- 2 x 90° (standard)
- 1 x 90° and 1 x 180°
- 2 x greater than 90°
- 2 x 90° protected mounting arrangement to the side of the clear opening
- 2 x 180°.

## Special mounting arrangements

- two swing doors, one above the other
- one swing door with a strip curtain or other climate control product above.

## Materials

### Construction

- galvanised steel, or stainless steel 304 (up to max. 3000 x 3000 mm).

### door leaf

- transparent, or reinforced transparent plastic sheet, 7 or 10 mm thick
- wear-resistant black rubber, 6 and 8 mm thick, with inlays
- ivory, black, grey, red or brown plastic sheet, 7 or 10 mm thick.

## Windows

- vision panel at a height between 1250 and 1750 mm from the floor
- high-frequency welded windows
- portholes fitted with safety glass.

## Finishes

Steel fabrications are thermally galvanised, but can also be sprayed in a variety of colours (RAL colour system). Stainless steel fabrications are etched.

## Dimensions

- max. width.....5000 mm
- max. height.....5000 mm
- max. surface area.....25 m<sup>2</sup>

## Operators

The forklift truck pushes the door open, following which the door automatically closes under the influence of the integral door closer.

## Structural requirements

Installation of Novoferm swing doors does not require the presence of a door-frame around the periphery of the opening. The entire weight of the door bears on the floor. A steel or concrete lintel is sufficient.

## Auxiliary components/ options/ accessories

- wear pads in a variety of positions
- (reinforced) cut-outs for overhead crane rails or pipework runs
- door stop
- mounting plate with welded pivots
- three-sided door-frame fitted with pivots
- door lock
- if required, swing doors can be operated automatically using a pneumatic or electric drive in combination with a wide variety of operators, or using Novoferm's semi-automatic pneumatic opener; ask for documentation.

**Arrangement 1**  
2 x 90°, in the clear opening

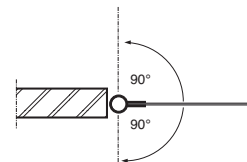

**Arrangement 2**  
1 x 90° and 1 x 180°  
in front of the clear opening

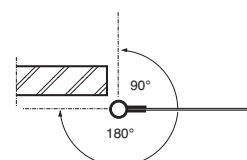

**Arrangement 3**  
2 x >90°, in the clear opening

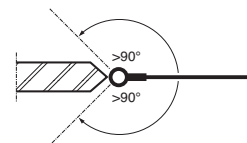

**Arrangement 4**  
2 x 90°, protected mounting arrangement in front of the clear opening

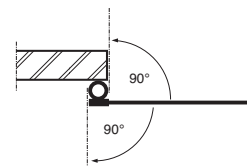

**Arrangement 5**  
2 x 180°, in the clear opening

